



1 Decay Scheme

Th-229 is a part of the $4n+1$ series of Neptunium decay chain which disintegrates entirely by alpha decay to the ground and the excited states in Ra-225.

Le thorium 229 appartient à la chaîne $4n+1$ du neptunium 237. Il se désintègre par émissions alpha vers des niveaux excités du radium 225.

2 Nuclear Data

$T_{1/2}(^{229}\text{Th})$:	7,88	(12)	10^3	a
$T_{1/2}(^{225}\text{Ra})$:	14,82	(19)	d	
$Q^\alpha(^{229}\text{Th})$:	5167,6	(10)	keV	

2.1 α Transitions

	Energy keV	Probability $\times 100$	F
$\alpha_{0,44}$	4558,7 (10)	0,005	44
$\alpha_{0,43}$	4563,1 (10)	0,03 (2)	8,1
$\alpha_{0,40}$	4680,4 (10)	0,02 (1)	83
$\alpha_{0,38}$	4689,5 (10)	0,050 (8)	39
$\alpha_{0,36}$	4750,8 (10)	0,001	5170
$\alpha_{0,33}$	4772,9 (10)	0,23 (8)	32
$\alpha_{0,30}$	4777,4 (10)	0,12 (2)	65
$\alpha_{0,29}$	4818,2 (10)	0,01	1560
$\alpha_{0,28}$	4832,2 (10)	0,005	3760
$\alpha_{0,27}$	4839,9 (10)	0,05	420
$\alpha_{0,26}$	4845,8 (10)	1,0 (4)	23
$\alpha_{0,24}$	4883,1 (10)	1,5 (2)	27
$\alpha_{0,23}$	4895,5 (10)	0,22	225
$\alpha_{0,22}$	4899,7 (10)	9,30 (8)	5,7
$\alpha_{0,20}$	4919 (1)	0,29	244
$\alpha_{0,19}$	4924 (1)	5,0 (2)	15,3

	Energy keV	Probability × 100	F
$\alpha_{0,18}$	4931,4 (10)	56,2 (2)	1,5
$\alpha_{0,17}$	4940,7 (10)	0,03	3300
$\alpha_{0,15}$	4947,1 (10)	0,28 (10)	386
$\alpha_{0,14}$	4951,3 (10)	0,03	3900
$\alpha_{0,13}$	4964,1 (10)	0,03	4600
$\alpha_{0,12}$	4987,8 (10)	10,20 (8)	19,4
$\alpha_{0,10}$	5017,6 (10)	0,16 (5)	1925
$\alpha_{0,8}$	5056 (1)	5,97 (6)	90
$\alpha_{0,6}$	5067,1 (10)	3,17 (4)	200
$\alpha_{0,5}$	5098,2 (10)	0,09 (1)	11000
$\alpha_{0,4}$	5112,4 (10)	0,009 (3)	130000
$\alpha_{0,3}$	5124,8 (10)	0,24 (2)	6024
$\alpha_{0,2}$	5136,04 (100)	0,2	3400
$\alpha_{0,1}$	5142,2 (10)	6,6 (1)	280
$\alpha_{0,0}$	5167,6 (10)	0,05 (1)	53000

2.2 Gamma Transitions and Internal Conversion Coefficients

	Energy keV	$P_{\gamma+ce}$ × 100	Multipolarity	α_K	α_L	α_M	α_T
$\gamma_{10,4}$ (Ra)	94,73 (8)	0,304 (23)	(E1)		0,0966 (14)	0,0233 (4)	0,1274 (18)
$\gamma_{9,1}$ (Ra)	94,92 (6)	0,0146 (34)	(E1)		0,0960 (14)	0,0232 (4)	0,1268 (18)
$\gamma_{40,30}$ (Ra)	97,01 (12)	0,011 (3)					
$\gamma_{20,10}$ (Ra)	98,86 (10)	0,120 (15)					
$\gamma_{26,15}$ (Ra)	101,1 (2)	0,018 (3)					
$\gamma_{33,25}$ (Ra)	101,58 (10)	0,049 (7)					
$\gamma_{7,0}$ (Ra)	101,58 (10)	0,049 (7)					
$\gamma_{27,16}$ (Ra)	102,54 (2)	0,160 (19)					
$\gamma_{24,12}$ (Ra)	104,6 (2)	0,058 (30)	(M1+E2)				5,4 (25)
$\gamma_{10,3}$ (Ra)	107,108 (8)	10,8 (10)	M1(+E2)	9,4 (19)	2,2 (6)	0,54 (17)	12,3 (11)
$\gamma_{15,8}$ (Ra)	109,2 (1)	0,58 (11)	(M1)	9,73 (14)	1,83 (3)	0,438 (7)	12,15 (18)
$\gamma_{21,10}$ (Ra)	110,3 (5)	0,009 (2)					
$\gamma_{12,5}$ (Ra)	110,332 (8)	0,171 (17)	(E1)	0,292 (4)	0,0645 (9)	0,01555 (22)	0,377 (6)
$\gamma_{42,38}$ (Ra)	114,75 (10)	0,0151 (22)					
$\gamma_{14,6}$ (Ra)	115,85 (10)	0,01					
$\gamma_{18,9}$ (Ra)	115,85 (10)	0,014	(E1)	0,261 (4)	0,0568 (8)	0,01367 (20)	0,336 (5)
$\gamma_{10,2}$ (Ra)	118,1 (1)	0,007 (3)					
$\gamma_{22,10}$ (Ra)	118,1 (1)	0,074 (23)	(E2)	0,308 (5)	3,24 (5)	0,881 (13)	4,72 (7)
$\gamma_{15,6}$ (Ra)	119,98 (2)	0,52 (21)	(M1)	7,46 (11)	1,394 (20)	0,333 (5)	9,30 (13)
$\gamma_{19,9}$ (Ra)	123,193 (13)	0,195 (9)	(E1)	0,226 (4)	0,0483 (7)	0,01162 (17)	0,290 (4)
$\gamma_{10,1}$ (Ra)	124,55 (5)	6,5 (6)	(M1)	6,71 (10)	1,252 (18)	0,299 (5)	8,36 (12)
$\gamma_{18,8}$ (Ra)	124,65 (5)	6,9 (6)	(M1)	6,69 (10)	1,249 (18)	0,299 (5)	8,34 (12)
$\gamma_{17,6}$ (Ra)	126,48 (10)	0,095 (42)	(M1,E2)	3 (3)	1,8 (6)	0,46 (18)	5,8 (23)
$\gamma_{33,22}$ (Ra)	126,48 (10)	0,061 (34)	(M1,E2)	3 (3)	1,8 (6)	0,46 (18)	5,8 (23)
$\gamma_{19,8}$ (Ra)	131,926 (5)	2,71 (10)	M1	5,70 (8)	1,061 (15)	0,254 (4)	7,1 (1)
$\gamma_{13,5}$ (Ra)	134,19 (10)	0,073 (12)	(M1)	5,43 (8)	1,011 (15)	0,242 (4)	6,76 (10)
$\gamma_{24,10}$ (Ra)	134,19 (10)	0,022 (11)	(E2)	0,296 (5)	1,81 (3)	0,491 (7)	2,75 (4)

	Energy keV	$P_{\gamma+ce}$ $\times 100$	Multipolarity	α_K	α_L	α_M	α_T
$\gamma_{33,21}$ (Ra)	134,19 (10)	0,0014 (7)					
$\gamma_{12,3}$ (Ra)	136,990 (4)	8,71 (25)	M1	5,12 (8)	0,953 (14)	0,228 (4)	6,38 (9)
$\gamma_{20,8}$ (Ra)	137,0 (1)	0,04 (1)					
$\gamma_{21,9}$ (Ra)	139,8 (1)	0,0045 (10)					
$\gamma_{26,12}$ (Ra)	142,0 (1)	0,035 (10)	(E2)	0,280 (4)	1,399 (20)	0,380 (6)	2,18 (4)
$\gamma_{19,6}$ (Ra)	142,962 (5)	2,69 (9)	M1	4,54 (7)	0,843 (12)	0,202 (3)	5,65 (8)
$\gamma_{22,9}$ (Ra)	147,64 (5)	0,237 (24)	E1	0,1475 (21)	0,0302 (5)	0,00724 (11)	0,187 (3)
$\gamma_{12,2}$ (Ra)	148,15 (4)	1,04 (7)	E1	0,1463 (21)	0,0299 (5)	0,00718 (10)	0,186 (3)
$\gamma_{10,0}$ (Ra)	150,04 (3)	0,33	(M1+E2)	3,4 (10)	0,78 (10)	0,19 (3)	4,5 (8)
$\gamma_{11,0}$ (Ra)	151,6 (3)	0,025					
$\gamma_{33,19}$ (Ra)	151,6 (3)	0,15	(M1)	3,84 (6)	0,713 (11)	0,170 (3)	4,78 (8)
$\gamma_{12,1}$ (Ra)	154,336 (10)	3,9 (6)	M1+E2	3,2 (9)	0,72 (8)	0,18 (3)	4,1 (8)
$\gamma_{22,8}$ (Ra)	156,409 (9)	6,40 (18)	M1	3,52 (5)	0,653 (10)	0,1560 (22)	4,38 (7)
$\gamma_{33,18}$ (Ra)	158,42 (12)	0,26 (7)	M1(+E2)	3,6 (15)	0,66 (10)	0,16 (4)	4,5 (14)
$\gamma_{23,8}$ (Ra)	160,6						
$\gamma_{30,17}$ (Ra)	163,34 (17)	0,097 (34)	(M1)	3,11 (5)	0,577 (9)	0,1378 (20)	3,87 (6)
$\gamma_{18,5}$ (Ra)	166,976 (7)	0,234 (11)	(E1)	0,1101 (16)	0,0220 (3)	0,00527 (8)	0,1391 (20)
$\gamma_{22,6}$ (Ra)	167,45 (8)	0,230 (46)	(M1)	2,90 (4)	0,537 (8)	0,1284 (18)	3,61 (5)
$\gamma_{31,16}$ (Ra)	169,2 (3)	0,0029 (14)					
$\gamma_{16,4}$ (Ra)	169,2 (3)	0,0010 (5)					
$\gamma_{30,15}$ (Ra)	169,2 (3)	0,0039 (14)					
$\gamma_{23,6}$ (Ra)	171,76 (5)	0,040 (4)					
$\gamma_{24,8}$ (Ra)	172,926 (18)	0,472 (43)	M1	2,65 (4)	0,490 (7)	0,1172 (17)	3,29 (5)
$\gamma_{30,14}$ (Ra)	173,93 (11)	0,0071 (18)					
$\gamma_{33,15}$ (Ra)	174,17 (15)	0,0067 (18)					
$\gamma_{19,5}$ (Ra)	174,20 (7)	0,0023		0,0998 (14)	0,0198 (3)	0,00474 (7)	0,1258 (18)
$\gamma_{37,23}$ (Ra)	174,7 (2)	0,030 (3)					
$\gamma_{12,0}$ (Ra)	179,757 (7)	0,368 (28)	E2	0,197 (3)	0,493 (7)	0,1334 (19)	0,867 (13)
$\gamma_{16,3}$ (Ra)	182,12 (10)	0,0054 (11)					
$\gamma_{35,15}$ (Ra)	183,0 (1)	0,0071 (12)					
$\gamma_{24,6}$ (Ra)	183,928 (8)	0,541 (27)	M1(+E2)	2,35	0,435	0,104	2,92
$\gamma_{38,25}$ (Ra)	185,6 (1)	0,002					
$\gamma_{28,10}$ (Ra)	185,6 (1)	0,002					
$\gamma_{37,21}$ (Ra)	186,1 (1)	0,013 (5)					
$\gamma_{42,35}$ (Ra)	189,25 (6)	0,0104 (21)					
$\gamma_{21,5}$ (Ra)	190,63 (20)	0,0101 (20)					
$\gamma_{16,2}$ (Ra)	193,52 (5)	0,0007 (3)					
$\gamma_{18,3}$ (Ra)	193,52 (5)	15,53	M1	2,03	0,377	0,09	2,53
$\gamma_{15,1}$ (Ra)	194,3 (3)	0,08 (6)	(M1,E2)	1,0 (9)	0,353 (6)	0,090 (6)	1,5 (9)
$\gamma_{19,3}$ (Ra)	200,807 (16)	0,1088 (48)	(E2)	0,1605 (23)	0,306 (5)	0,0826 (12)	0,577 (8)
$\gamma_{18,2}$ (Ra)	204,690 (5)	0,640 (33)	(E1)	0,0681 (10)	0,01312 (19)	0,00314 (5)	0,0854 (12)
$\gamma_{26,8}$ (Ra)	210,15 (8)	0,55 (12)	(M1)	1,531 (22)	0,283 (4)	0,0676 (10)	1,90 (3)
$\gamma_{18,1}$ (Ra)	210,853 (3)	8,1 (9)	M1	1,517 (22)	0,280 (4)	0,0669 (10)	1,89 (3)
$\gamma_{41,26}$ (Ra)	213,48 (5)	0,0087 (16)					
$\gamma_{24,5}$ (Ra)	215,10 (1)	0,147 (11)	(E1)	0,0606 (9)	0,01160 (17)	0,00277 (4)	0,0759 (11)
$\gamma_{27,8}$ (Ra)	216,0 (1)	0,053 (6)					
$\gamma_{21,3}$ (Ra)	217,41 (10)	0,0065 (11)					
$\gamma_{19,1}$ (Ra)	218,154 (17)	0,49 (5)	M1	1,379 (20)	0,255 (4)	0,0608 (9)	1,715 (24)
$\gamma_{34,12}$ (Ra)	219,8 (1)	0,0033 (8)					
$\gamma_{37,17}$ (Ra)	219,8 (1)	0,0008					
$\gamma_{26,6}$ (Ra)	221,22 (5)	0,058 (16)	(M1)	1,327 (19)	0,245 (4)	0,0585 (9)	1,650 (24)
$\gamma_{16,0}$ (Ra)	225,26 (10)	0,003 (1)					
$\gamma_{22,3}$ (Ra)	225,26 (10)	0,086 (8)	(E2)	0,1279 (18)	0,189 (3)	0,0508 (8)	0,384 (6)
$\gamma_{21,2}$ (Ra)	228,6 (1)	0,0006 (2)					
$\gamma_{21,1}$ (Ra)	234,8 (1)	0,0008 (2)					
$\gamma_{38,19}$ (Ra)	234,8 (1)	0,0008					
$\gamma_{18,0}$ (Ra)	236,249 (20)	0,231 (12)	E2	0,1161 (17)	0,1552 (22)	0,0417 (6)	0,327 (5)
$\gamma_{22,1}$ (Ra)	242,6 (2)	0,189 (18)	M1	1,026 (15)	0,189 (3)	0,0451 (7)	1,275 (18)
$\gamma_{31,10}$ (Ra)	244,4 (1)	0,0013 (3)					

	Energy keV	$P_{\gamma+ce}$ $\times 100$	Multipolarity	α_K	α_L	α_M	α_T
$\gamma_{25,3}$ (Ra)	250,1 (1)	0,00034 (16)					
$\gamma_{26,5}$ (Ra)	252,43 (3)	0,100 (13)	(E1)	0,0419 (6)	0,00783 (11)	0,00187 (3)	0,0522 (8)
$\gamma_{24,1}$ (Ra)	259,08 (4)	0,07 (1)	(M1)	0,855 (12)	0,1574 (22)	0,0376 (6)	1,063 (15)
$\gamma_{25,1}$ (Ra)	267,4 (1)	0,0008 (3)					
$\gamma_{33,9}$ (Ra)	274,1 (1)	0,0007 (2)					
$\gamma_{43,27}$ (Ra)	276,85 (10)	0,0042 (10)					
$\gamma_{30,8}$ (Ra)	278,65 (5)	0,0068 (8)					
$\gamma_{44,27}$ (Ra)	281,27 (10)	0,007 (1)					
$\gamma_{33,8}$ (Ra)	282,6 (1)	0,0038 (7)					
$\gamma_{30,6}$ (Ra)	289,62 (5)	0,0150 (17)					
$\gamma_{8,6}$ (Ra)	11,10 (8)	12,0 (18)	(M1+E2)			40000 (5)	60000 (6)
$\gamma_{43,42}$ (Ra)	11,79 (20)	0,0005					
$\gamma_{3,1}$ (Ra)	17,360 (36)	24 (12)	(M1)		2,90 (5)	97,5 (15)	133,2 (21)
$\gamma_{4,2}$ (Ra)	23,60 (7)	0,291 (24)	(M1+E2)		182 (9)	43,9 (24)	241,33
$\gamma_{1,0}$ (Ra)	25,39 (2)	58 (29)	(E2)		5330 (80)	1436 (21)	7240 (110)
$\gamma_{23,19}$ (Ra)	28,68 (10)	0,10 (3)					
$\gamma_{12,10}$ (Ra)	29,9 (1)	24,6 (45)	(M1+E2)		167	42	223
$\gamma_{10,9}$ (Ra)	29,9 (1)	0,002					
$\gamma_{6,5}$ (Ra)	31,10 (5)	2,92 (28)	(E1)		1,86 (3)	0,466 (7)	2,48 (4)
$\gamma_{2,0}$ (Ra)	31,50 (5)	4,03 (14)	E1		1,80 (3)	0,450 (7)	2,39 (4)
$\gamma_{22,18}$ (Ra)	31,57 (9)	6,3 (9)	(M1)		69,0 (12)	16,5 (3)	91,1 (15)
$\gamma_{25,21}$ (Ra)	33,04 (20)	0,01					
$\gamma_{5,2}$ (Ra)	37,8 (1)	3,3 (16)	(E2)		753 (15)	203 (4)	1023 (20)
$\gamma_{8,5}$ (Ra)	42,3 (1)	0,172 (17)	(E1)		0,826 (13)	0,203 (4)	1,094 (17)
$\gamma_{3,0}$ (Ra)	42,82 (5)	12,2 (31)	(M1+E2)		56 (14)	14 (4)	75 (19)
$\gamma_{5,1}$ (Ra)	43,99 (1)	1,31 (6)	E1		0,744 (11)	0,183 (3)	0,985 (14)
$\gamma_{22,15}$ (Ra)	46,52 (4)	0,021 (2)					
$\gamma_{26,23}$ (Ra)	49,75 (8)	0,58 (5)	(M1)		19,1	4,57	25,2
$\gamma_{9,5}$ (Ra)	50,99 (4)	0,39 (9)	(M1)		16,81 (24)	4,02 (6)	22,2 (4)
$\gamma_{26,22}$ (Ra)	53,75 (20)	0,22 (6)	(M1)		14,4 (3)	3,45 (7)	19,0 (4)
$\gamma_{4,0}$ (Ra)	55,11 (3)	0,0042 (6)	(E1)		0,408 (6)	0,0996 (14)	0,540 (8)
$\gamma_{18,12}$ (Ra)	56,518 (5)	5,5 (15)	M1(+E2)		14 (4)	3,3 (9)	18 (5)
$\gamma_{12,9}$ (Ra)	59,33 (10)	0,012 (2)					
$\gamma_{24,15}$ (Ra)	63,7 (2)	0,005 (2)					
$\gamma_{9,4}$ (Ra)	64,96 (10)	0,087 (11)					
$\gamma_{25,17}$ (Ra)	65,91 (10)	0,161 (17)					
$\gamma_{12,8}$ (Ra)	68,09 (4)	1,04 (38)	M1+E2		11 (4)	2,7 (10)	14 (5)
$\gamma_{15,11}$ (Ra)	68,8 (1)	0,04					
$\gamma_{20,12}$ (Ra)	68,8 (10)	0,09					
$\gamma_{23,13}$ (Ra)	68,8						
$\gamma_{8,3}$ (Ra)	68,83 (3)	7,7 (7)	E2		41,1 (6)	11,16 (16)	55,9 (8)
$\gamma_{33,26}$ (Ra)	72,739 (10)	0,14 (2)					
$\gamma_{6,1}$ (Ra)	75,1 (1)	23,1 (49)	E2		27,1 (5)	7,36 (12)	36,9 (6)
$\gamma_{16,10}$ (Ra)	75,19 (10)	0,002 (1)					
$\gamma_{9,3}$ (Ra)	77,63 (5)	0,055 (7)	(E1)		0,1638 (24)	0,0397 (6)	0,216 (3)
$\gamma_{26,19}$ (Ra)	78,3 (2)	0,059 (15)	(M1)		4,79 (8)	1,147 (19)	6,33 (10)
$\gamma_{8,1}$ (Ra)	86,25 (4)	8,7 (11)	M1+E2		4,3 (5)	1,07 (14)	5,7 (7)
$\gamma_{18,10}$ (Ra)	86,40 (5)	100,0 (19)	M1		3,60 (5)	0,861 (13)	4,75 (7)
$\gamma_{29,21}$ (Ra)	89,09 (20)	0,01					
$\gamma_{36,27}$ (Ra)	89,09 (20)	0,005					
$\gamma_{9,2}$ (Ra)	89,09 (20)	0,14					
$\gamma_{26,17}$ (Ra)	94,7 (1)	0,028 (10)					
$\gamma_{33,6}$ (Ra)	293,78 (10)	0,0065 (8)					
$\gamma_{26,1}$ (Ra)	296,21 (10)	0,0191 (20)	(E2)	0,0728 (11)	0,0630 (9)	0,01675 (24)	0,1581 (23)
$\gamma_{38,12}$ (Ra)	298,72 (12)	0,0070 (8)					
$\gamma_{28,2}$ (Ra)	303,75 (10)	0,0017 (30)					
$\gamma_{39,12}$ (Ra)	307,3 (1)	0,006 (3)					
$\gamma_{28,1}$ (Ra)	310,1 (1)	0,0020 (3)					
$\gamma_{45,29}$ (Ra)	313,3 (1)	0,0037 (11)					

	Energy keV	$P_{\gamma+ce}$ $\times 100$	Multipolarity	α_K	α_L	α_M	α_T
$\gamma_{29,2}$ (Ra)	317,8 (1)	0,00055 (14)					
$\gamma_{42,23}$ (Ra)	320,8 (1)	0,00016 (7)					
$\gamma_{31,5}$ (Ra)	324,6 (1)	0,00043 (13)					
$\gamma_{45,28}$ (Ra)	327,9 (1)	0,003					
$\gamma_{27,0}$ (Ra)	327,9 (1)	0,016 (3)					
$\gamma_{38,10}$ (Ra)	328,2 (1)	0,0020 (8)					
$\gamma_{34,5}$ (Ra)	329,9 (2)	0,0006 (2)					
$\gamma_{37,8}$ (Ra)	334,74 (10)	0,00043 (11)					
$\gamma_{39,10}$ (Ra)	336,7 (1)	0,0001					
$\gamma_{43,22}$ (Ra)	336,7 (1)	0,0082 (1)					
$\gamma_{45,26}$ (Ra)	341,1 (1)	0,0008 (2)					
$\gamma_{34,4}$ (Ra)	344,3 (1)	0,0001					
$\gamma_{36,5}$ (Ra)	347,4 (1)	0,0006 (1)					
$\gamma_{42,19}$ (Ra)	349,4 (1)	0,0001					
$\gamma_{29,0}$ (Ra)	349,4 (1)	0,0004 (1)					
$\gamma_{32,3}$ (Ra)	351,7 (1)	0,0005 (1)					
$\gamma_{38,9}$ (Ra)	358,0 (1)	0,006 (1)					
$\gamma_{43,19}$ (Ra)	361,0 (1)	0,0006 (1)					
$\gamma_{38,8}$ (Ra)	366,5 (1)	0,0004 (1)					
$\gamma_{39,9}$ (Ra)	366,5 (1)	0,0001					
$\gamma_{43,18}$ (Ra)	368,1 (1)	0,0019 (3)					
$\gamma_{31,1}$ (Ra)	368,9 (1)	0,0019 (3)					
$\gamma_{39,8}$ (Ra)	375,1 (1)	0,0003 (1)					
$\gamma_{38,6}$ (Ra)	377,4 (1)	0,0029 (3)					
$\gamma_{43,16}$ (Ra)	379,4 (1)	0,0013 (2)					
$\gamma_{39,6}$ (Ra)	386,4 (1)	0,0008 (2)					
$\gamma_{32,0}$ (Ra)	395,3 (2)	0,0008 (1)					
$\gamma_{34,0}$ (Ra)	399,9 (2)	0,00014 (6)					
$\gamma_{35,0}$ (Ra)	403,3 (1)	0,0018 (2)					
$\gamma_{38,5}$ (Ra)	408,5 (1)	0,0010 (1)					
$\gamma_{41,9}$ (Ra)	414,61 (10)	0,0003 (1)					
$\gamma_{39,5}$ (Ra)	417,4 (1)	0,0014 (2)					
$\gamma_{45,19}$ (Ra)	419,9 (2)	0,0006 (1)					
$\gamma_{43,12}$ (Ra)	424,8 (1)	0,0032 (3)					
$\gamma_{38,3}$ (Ra)	435,3 (1)	0,0031 (4)					
$\gamma_{39,3}$ (Ra)	444,1 (1)	0,0005 (1)					
$\gamma_{38,1}$ (Ra)	452,6 (1)	0,0017 (2)					
$\gamma_{43,10}$ (Ra)	454,76 (10)	0,0105 (11)					
$\gamma_{44,10}$ (Ra)	459,1 (3)	0,001					
$\gamma_{41,5}$ (Ra)	465 (1)	0,0001					
$\gamma_{38,0}$ (Ra)	478,0 (1)	0,0037 (4)					
$\gamma_{45,12}$ (Ra)	483,7 (1)	0,0018 (2)					
$\gamma_{39,0}$ (Ra)	487,32 (20)	0,0004 (1)					
$\gamma_{43,8}$ (Ra)	492,9 (1)	0,00152 (16)					
$\gamma_{43,6}$ (Ra)	503,6 (1)	0,00005					
$\gamma_{41,2}$ (Ra)	503,6 (1)	0,00012 (5)					
$\gamma_{45,10}$ (Ra)	513,5 (2)	0,0007 (2)					
$\gamma_{42,5}$ (Ra)	523,5 (1)	0,0005 (1)					
$\gamma_{41,0}$ (Ra)	535,1 (1)	0,0013 (2)					
$\gamma_{43,5}$ (Ra)	535,1 (1)	0,0002					
$\gamma_{45,9}$ (Ra)	543,0 (3)	0,0001					
$\gamma_{42,3}$ (Ra)	549,8 (5)	0,0001					
$\gamma_{45,8}$ (Ra)	551,7 (2)	0,00011 (4)					
$\gamma_{43,3}$ (Ra)	561,8 (1)	0,0019 (2)					
$\gamma_{44,3}$ (Ra)	565,7 (3)	0,0009 (1)					
$\gamma_{43,2}$ (Ra)	573,0 (1)	0,0028 (3)					
$\gamma_{43,1}$ (Ra)	579,2 (2)	0,0006 (1)					
$\gamma_{42,0}$ (Ra)	592,5 (1)	0,0003 (1)					
$\gamma_{45,5}$ (Ra)	594,4 (3)	0,0001					

3 Atomic Data

3.1 Ra

ω_K	:	0,968	(4)
$\bar{\omega}_L$:	0,452	(18)
n_{KL}	:	0,801	(5)

3.1.1 X Radiations

	Energy keV	Relative probability
X _K		
K α_2	85,43	61,22
K α_1	88,47	100
K β_3	99,432	}
K β_1	100,13	}
K β_5''	100,738	}
		35,08
K β_2	102,89	}
K β_4	103,295	}
K $O_{2,3}$	103,74	}
		11,51
X _L		
L ℓ	10,62	
L α	12,2 – 12,34	
L η	13,66	
L β	14,24 – 15,45	
L γ	17,85 – 18,41	

3.1.2 Auger Electrons

	Energy keV	Relative probability
Auger K		
KLL	65,149 – 72,729	100
KLX	79,721 – 88,466	57,8
KXY	94,27 – 103,91	8,35
Auger L	5,71 – 12,04	

4 α Emissions

	Energy keV	Probability $\times 100$
$\alpha_{0,44}$	4478 (3)	0,005
$\alpha_{0,43}$	4484 (2)	0,03 (2)
$\alpha_{0,40}$	4599 (3)	0,02 (1)
$\alpha_{0,38}$	4608 (2)	0,050 (8)
$\alpha_{0,36}$	4667	0,001
$\alpha_{0,33}$	4690 (2)	0,23 (8)
$\alpha_{0,30}$	4694 (2)	0,12 (2)
$\alpha_{0,29}$	4737	0,01
$\alpha_{0,28}$	4748	0,005
$\alpha_{0,27}$	4754	0,05
$\alpha_{0,26}$	4761 (2)	1,0 (4)
$\alpha_{0,24}$	4797,8 (12)	1,5 (2)
$\alpha_{0,23}$	4809	0,22
$\alpha_{0,22}$	4814,6 (12)	9,30 (8)
$\alpha_{0,20}$	4833	0,29
$\alpha_{0,19}$	4838 (2)	5,0 (2)
$\alpha_{0,18}$	4845,3 (12)	56,2 (2)
$\alpha_{0,17}$	4852	0,03
$\alpha_{0,15}$	4861 (2)	0,28 (10)
$\alpha_{0,14}$	4865	0,03
$\alpha_{0,13}$	4878	0,03
$\alpha_{0,12}$	4901,0 (12)	10,20 (8)
$\alpha_{0,10}$	4930 (2)	0,16 (5)
$\alpha_{0,8}$	4967,5 (12)	5,97 (6)
$\alpha_{0,6}$	4978,5 (12)	3,17 (4)
$\alpha_{0,5}$	5009 (2)	0,09 (1)
$\alpha_{0,4}$	5023 (2)	0,009 (3)
$\alpha_{0,3}$	5036 (2)	0,24 (2)
$\alpha_{0,2}$	5047 (2)	0,2
$\alpha_{0,1}$	5053 (2)	6,6 (1)
$\alpha_{0,0}$	5078 (2)	0,05 (1)

5 Electron Emissions

		Energy keV	Electrons per 100 disint.
e _{AL}	(Ra)	5,71 - 12,04	132 (7)
e _{AK}	(Ra)		1,60 (21)
	KLL	65,149 - 72,729	}
	KLX	79,721 - 88,466	}
	KXY	94,27 - 103,91	}
ec _{3,1 L}	(Ra)	1,92 - 1,92	0,52 (26)
ec _{10,3 K}	(Ra)	3,193 (8)	7,6 (16)
ec _{4,2 L}	(Ra)	4,4 - 8,2	0,218 (21)
ec _{15,8 K}	(Ra)	5,285 (8)	0,45 (11)
ec _{1,0 L}	(Ra)	6,16 - 9,95	43 (21)
ec _{12,10 L}	(Ra)	10,7 - 14,5	18,4 (33)
ec _{6,5 L}	(Ra)	11,9 - 15,7	1,56 (15)
ec _{2,0 L}	(Ra)	12,3 - 16,1	2,14 (8)
ec _{22,18 L}	(Ra)	12,34 - 16,13	4,7 (7)
ec _{3,1 M}	(Ra)	12,54 - 14,26	18 (9)
ec _{15,6 K}	(Ra)	16,065 (8)	0,402 (3)
ec _{3,1 N}	(Ra)	16,15 - 17,08	4,6 (23)
ec _{5,2 L}	(Ra)	18,6 - 22,4	2,4 (12)
ec _{1,0 M}	(Ra)	20,57 - 22,28	11 (6)
ec _{10,1 K}	(Ra)	20,63 (5)	4,63 (41)
ec _{18,8 K}	(Ra)	20,74 (5)	4,95 (41)
ec _{3,0 L}	(Ra)	23,59 - 27,38	9,0 (23)
ec _{1,0 N}	(Ra)	24,18 - 25,11	3,0 (15)
ec _{5,1 L}	(Ra)	24,76 - 28,55	0,491 (23)
ec _{12,10 M}	(Ra)	25,1 - 26,8	4,6 (8)
ec _{6,5 M}	(Ra)	26,3 - 28,0	0,391 (38)
ec _{2,0 M}	(Ra)	26,7 - 28,4	0,536 (20)
ec _{22,18 M}	(Ra)	26,75 - 28,46	1,12 (17)
ec _{19,8 K}	(Ra)	28,011 (5)	1,91 (7)
ec _{6,5 N}	(Ra)	29,9 - 30,8	0,10 (1)
ec _{2,0 N}	(Ra)	30,3 - 31,2	0,137 (5)
ec _{22,18 N}	(Ra)	30,36 - 31,29	0,297 (44)
ec _{26,23 L}	(Ra)	30,518 - 34,306	0,42 (6)
ec _{9,5 L}	(Ra)	31,76 - 35,55	0,29 (7)
ec _{5,2 M}	(Ra)	33,0 - 34,7	0,65 (33)
ec _{12,3 K}	(Ra)	33,075 (4)	6,04 (18)
ec _{26,22 L}	(Ra)	34,52 - 38,31	0,158 (43)
ec _{5,2 N}	(Ra)	36,6 - 37,5	0,17 (9)
ec _{18,12 L}	(Ra)	37,286 - 41,074	4,1 (12)
ec _{3,0 M}	(Ra)	38,00 - 39,72	2,2 (7)
ec _{19,6 K}	(Ra)	39,047 (5)	1,83 (6)
ec _{5,1 M}	(Ra)	39,17 - 40,89	0,121 (6)
ec _{3,0 N}	(Ra)	41,61 - 42,54	0,61 (16)

		Energy keV	Electrons per 100 disint.
ec _{12,2} K	(Ra)	44,24 (4)	0,129 (9)
ec _{26,23} M	(Ra)	44,928 - 46,645	0,10 (2)
ec _{10,0} K	(Ra)	46,12 (3)	0,20 (6)
ec _{12,8} L	(Ra)	48,86 - 52,65	0,76 (30)
ec _{8,3} L	(Ra)	49,60 - 53,39	5,6 (5)
ec _{12,1} K	(Ra)	50,42 (1)	2,5 (7)
ec _{18,12} M	(Ra)	51,696 - 53,413	0,96 (27)
ec _{22,8} K	(Ra)	52,494 (9)	4,19 (12)
ec _{33,18} K	(Ra)	54,50 (12)	0,17 (7)
ec _{18,12} N	(Ra)	55,310 - 56,239	0,25 (7)
ec _{6,1} L	(Ra)	55,9 - 59,7	16,5 (35)
ec _{12,8} M	(Ra)	63,27 - 64,98	0,19 (7)
ec _{22,6} K	(Ra)	63,53 (8)	0,145 (29)
ec _{8,3} M	(Ra)	64,01 - 65,72	1,52 (15)
ec _{8,1} L	(Ra)	67,02 - 70,81	5,6 (8)
ec _{18,10} L	(Ra)	67,2 - 71,0	93,6 (13)
ec _{8,3} N	(Ra)	67,62 - 68,55	0,401 (39)
ec _{24,8} K	(Ra)	69,011 (18)	0,292 (27)
ec _{6,1} M	(Ra)	70,3 - 72,0	4,5 (10)
ec _{6,1} N	(Ra)	73,9 - 74,8	1,18 (25)
ec _{24,6} K	(Ra)	80,013 (8)	0,324 (16)
ec _{8,1} M	(Ra)	81,43 - 83,14	1,39 (21)
ec _{18,10} M	(Ra)	81,6 - 83,3	22,39 (35)
ec _{8,1} N	(Ra)	85,04 - 85,97	0,36 (6)
ec _{18,10} N	(Ra)	85,2 - 86,1	5,90 (11)
ec _{10,3} L	(Ra)	87,876 - 91,664	1,78 (49)
ec _{18,3} K	(Ra)	89,60 (5)	8,9
ec _{10,3} M	(Ra)	102,286 - 104,003	0,44 (14)
ec _{10,1} L	(Ra)	105,32 - 109,11	0,86 (8)
ec _{18,8} L	(Ra)	105,42 - 109,21	0,92 (8)
ec _{10,3} N	(Ra)	105,900 - 106,829	0,113 (41)
ec _{26,8} K	(Ra)	106,24 (8)	0,29 (6)
ec _{18,1} K	(Ra)	106,938 (3)	4,25 (46)
ec _{19,8} L	(Ra)	112,694 - 116,482	0,355 (14)
ec _{19,1} K	(Ra)	114,239 (17)	0,248 (28)
ec _{12,3} L	(Ra)	117,76 - 121,55	1,125 (33)
ec _{10,1} M	(Ra)	119,73 - 121,44	0,206 (18)
ec _{18,8} M	(Ra)	119,83 - 121,54	0,221 (18)
ec _{19,6} L	(Ra)	123,730 - 127,518	0,341 (11)
ec _{12,3} M	(Ra)	132,17 - 133,89	0,269 (8)
ec _{12,1} L	(Ra)	135,104 - 138,892	0,55 (6)
ec _{22,8} L	(Ra)	137,177 - 140,965	0,777 (23)
ec _{12,1} M	(Ra)	149,514 - 151,231	0,139 (23)
ec _{22,8} M	(Ra)	151,587 - 153,304	0,186 (5)
ec _{18,3} L	(Ra)	174,29 - 178,08	1,6
ec _{18,3} M	(Ra)	188,70 - 190,42	0,4
ec _{18,1} L	(Ra)	191,621 - 195,409	0,78 (8)

		Energy keV	Electrons per 100 disint.
ec _{18,3} N	(Ra)	192,31 - 193,24	0,14
ec _{18,1} M	(Ra)	206,031 - 207,748	0,187 (20)

6 Photon Emissions

6.1 X-Ray Emissions

		Energy keV	Photons per 100 disint.	
XL	(Ra)	10,62 — 18,41	106 (7)	
XK α_2	(Ra)	85,43	14,3 (6)	} K α
XK α_1	(Ra)	88,47	23,4 (9)	
XK β_3	(Ra)	99,432	}	K' β_1
XK β_1	(Ra)	100,13		
XK β_5''	(Ra)	100,738		
XK β_2	(Ra)	102,89	}	K' β_2
XK β_4	(Ra)	103,295		
XKO _{2,3}	(Ra)	103,74		

6.2 Gamma Emissions

	Energy keV	Photons per 100 disint.
$\gamma_{8,6}$ (Ra)	11,10 (8)	0,00020 (3)
$\gamma_{43,42}$ (Ra)	11,79 (20)	0,0005
$\gamma_{3,1}$ (Ra)	17,360 (36)	0,18 (9)
$\gamma_{4,2}$ (Ra)	23,6	0,0012 (1)
$\gamma_{1,0}$ (Ra)	25,39 (2)	0,008 (4)
$\gamma_{23,19}$ (Ra)	28,68 (10)	0,10 (3)
$\gamma_{12,10}$ (Ra)	29,9 (1)	0,11 (2)
$\gamma_{10,9}$ (Ra)	29,9 (1)	0,002
$\gamma_{6,5}$ (Ra)	31,10 (5)	0,84 (8)
$\gamma_{2,0}$ (Ra)	31,50 (5)	1,19 (4)
$\gamma_{22,18}$ (Ra)	31,57 (9)	0,068 (10)
$\gamma_{25,21}$ (Ra)	33,04 (20)	0,01
$\gamma_{5,2}$ (Ra)	37,8 (1)	0,0032 (16)
$\gamma_{8,5}$ (Ra)	42,3 (1)	0,082 (8)
$\gamma_{3,0}$ (Ra)	42,82 (5)	0,16 (1)

	Energy keV	Photons per 100 disint.
$\gamma_{5,1}$ (Ra)	43,99 (1)	0,66 (3)
$\gamma_{22,15}$ (Ra)	46,52 (4)	0,021 (2)
$\gamma_{26,23}$ (Ra)	49,75 (8)	0,022 (2)
$\gamma_{9,5}$ (Ra)	50,99 (4)	0,017 (4)
$\gamma_{26,22}$ (Ra)	53,75 (20)	0,011 (3)
$\gamma_{4,0}$ (Ra)	55,11 (3)	0,0027 (4)
$\gamma_{18,12}$ (Ra)	56,518 (5)	0,29 (2)
$\gamma_{12,9}$ (Ra)	59,33 (10)	0,012 (2)
$\gamma_{24,15}$ (Ra)	63,7 (2)	0,005 (2)
$\gamma_{9,4}$ (Ra)	64,96 (10)	0,087 (11)
$\gamma_{25,17}$ (Ra)	65,91 (10)	0,161 (17)
$\gamma_{12,8}$ (Ra)	68,09 (4)	0,069 (10)
$\gamma_{15,11}$ (Ra)	68,8 (1)	0,04
$\gamma_{20,12}$ (Ra)	68,8 (10)	0,09
$\gamma_{8,3}$ (Ra)	68,83 (3)	0,136 (13)
$\gamma_{33,26}$ (Ra)	72,739 (10)	0,14 (2)
$\gamma_{6,1}$ (Ra)	75,1 (1)	0,61 (13)
$\gamma_{16,10}$ (Ra)	75,19 (10)	0,002 (1)
$\gamma_{9,3}$ (Ra)	77,63 (5)	0,045 (6)
$\gamma_{26,19}$ (Ra)	78,3 (2)	0,008 (2)
$\gamma_{8,1}$ (Ra)	86,25 (4)	1,3 (1)
$\gamma_{18,10}$ (Ra)	86,40 (5)	26,0 (1)
$\gamma_{29,21}$ (Ra)	89,09 (20)	0,01
$\gamma_{36,27}$ (Ra)	89,09 (20)	0,005
$\gamma_{9,2}$ (Ra)	89,09 (20)	0,14
$\gamma_{26,17}$ (Ra)	94,7 (1)	0,028 (10)
$\gamma_{10,4}$ (Ra)	94,73 (8)	0,27 (2)
$\gamma_{9,1}$ (Ra)	94,92 (8)	0,013 (3)
$\gamma_{40,30}$ (Ra)	97,01 (12)	0,011 (3)
$\gamma_{20,10}$ (Ra)	98,86 (10)	0,120 (15)
$\gamma_{26,15}$ (Ra)	101,1 (2)	0,018 (3)
$\gamma_{7,0}$ (Ra)	101,58 (10)	0,049 (7)
$\gamma_{33,25}$ (Ra)	101,58 (10)	0,049 (7)
$\gamma_{27,16}$ (Ra)	102,54 (2)	0,160 (19)
$\gamma_{24,12}$ (Ra)	104,6 (2)	0,009 (3)
$\gamma_{10,3}$ (Ra)	107,108 (8)	0,81 (4)
$\gamma_{15,8}$ (Ra)	109,1 (1)	0,044 (8)
$\gamma_{21,10}$ (Ra)	110,3 (5)	0,009 (2)
$\gamma_{12,5}$ (Ra)	110,332 (8)	0,124 (12)
$\gamma_{42,38}$ (Ra)	114,75 (10)	0,0151 (22)
$\gamma_{14,6}$ (Ra)	115,85 (10)	0,01
$\gamma_{18,9}$ (Ra)	115,85 (10)	0,01
$\gamma_{10,2}$ (Ra)	118,1 (1)	0,007 (3)
$\gamma_{22,10}$ (Ra)	118,1 (1)	0,013 (4)
$\gamma_{15,6}$ (Ra)	119,98 (2)	0,05 (2)
$\gamma_{19,9}$ (Ra)	123,193 (13)	0,151 (7)
$\gamma_{10,1}$ (Ra)	124,55 (5)	0,69 (6)

	Energy keV	Photons per 100 disint.
$\gamma_{18,8}(\text{Ra})$	124,65 (5)	0,74 (6)
$\gamma_{33,22}(\text{Ra})$	126,48 (10)	0,009 (4)
$\gamma_{17,6}(\text{Ra})$	126,48 (10)	0,014 (4)
$\gamma_{19,8}(\text{Ra})$	131,926 (5)	0,335 (12)
$\gamma_{13,5}(\text{Ra})$	134,19 (10)	0,0094 (15)
$\gamma_{24,10}(\text{Ra})$	134,19 (10)	0,006 (3)
$\gamma_{33,21}(\text{Ra})$	134,19 (10)	0,0014 (7)
$\gamma_{12,3}(\text{Ra})$	136,990 (4)	1,18 (3)
$\gamma_{20,8}(\text{Ra})$	137,0 (1)	0,04 (1)
$\gamma_{21,9}(\text{Ra})$	139,8 (1)	0,0045 (10)
$\gamma_{26,12}(\text{Ra})$	142,0 (1)	0,011 (3)
$\gamma_{19,6}(\text{Ra})$	142,962 (5)	0,404 (12)
$\gamma_{22,9}(\text{Ra})$	147,64 (5)	0,20 (2)
$\gamma_{12,2}(\text{Ra})$	148,15 (4)	0,88 (6)
$\gamma_{10,0}(\text{Ra})$	150,04 (3)	0,06
$\gamma_{11,0}(\text{Ra})$	151,6 (3)	0,025
$\gamma_{33,19}(\text{Ra})$	151,6 (3)	0,025
$\gamma_{12,1}(\text{Ra})$	154,336 (10)	0,77 (2)
$\gamma_{22,8}(\text{Ra})$	156,409 (9)	1,19 (3)
$\gamma_{33,18}(\text{Ra})$	158,42 (12)	0,048 (5)
$\gamma_{30,17}(\text{Ra})$	163,34 (17)	0,020 (7)
$\gamma_{18,5}(\text{Ra})$	166,976 (7)	0,205 (10)
$\gamma_{22,6}(\text{Ra})$	167,45 (5)	0,05 (1)
$\gamma_{31,16}(\text{Ra})$	169,2 (3)	0,0029 (14)
$\gamma_{16,4}(\text{Ra})$	169,2 (3)	0,0010 (5)
$\gamma_{30,15}(\text{Ra})$	169,2 (3)	0,0039 (14)
$\gamma_{23,6}(\text{Ra})$	171,76 (5)	0,040 (4)
$\gamma_{24,8}(\text{Ra})$	172,926 (18)	0,11 (1)
$\gamma_{19,5}(\text{Ra})$	174,05 (7)	0,002
$\gamma_{30,14}(\text{Ra})$	174,05 (11)	0,0071 (18)
$\gamma_{33,15}(\text{Ra})$	174,05 (11)	0,0067 (18)
$\gamma_{37,23}(\text{Ra})$	174,7 (2)	0,030 (3)
$\gamma_{12,0}(\text{Ra})$	179,757 (7)	0,197 (15)
$\gamma_{16,3}(\text{Ra})$	182,12 (10)	0,0054 (11)
$\gamma_{35,15}(\text{Ra})$	183,0 (1)	0,0071 (12)
$\gamma_{24,6}(\text{Ra})$	183,928 (8)	0,138 (7)
$\gamma_{38,25}(\text{Ra})$	185,6 (1)	0,002
$\gamma_{28,10}(\text{Ra})$	185,6 (1)	0,002
$\gamma_{37,21}(\text{Ra})$	186,1 (1)	0,013 (5)
$\gamma_{42,35}(\text{Ra})$	189,25 (6)	0,0104 (21)
$\gamma_{21,5}(\text{Ra})$	190,63 (20)	0,0101 (20)
$\gamma_{16,2}(\text{Ra})$	193,52 (5)	0,0007 (3)
$\gamma_{18,3}(\text{Ra})$	193,52 (5)	4,4
$\gamma_{15,1}(\text{Ra})$	194,3 (3)	0,03 (2)
$\gamma_{19,3}(\text{Ra})$	200,807 (16)	0,069 (3)
$\gamma_{18,2}(\text{Ra})$	204,690 (5)	0,59 (3)
$\gamma_{26,8}(\text{Ra})$	210,15 (8)	0,19 (4)

	Energy keV	Photons per 100 disint.
$\gamma_{18,1}$ (Ra)	210,853 (3)	2,8 (3)
$\gamma_{41,26}$ (Ra)	213,48 (5)	0,0087 (16)
$\gamma_{24,5}$ (Ra)	215,10 (1)	0,137 (10)
$\gamma_{27,8}$ (Ra)	216,0 (1)	0,053 (6)
$\gamma_{21,3}$ (Ra)	217,41 (10)	0,0065 (11)
$\gamma_{19,1}$ (Ra)	218,154 (17)	0,18 (2)
$\gamma_{34,12}$ (Ra)	219,8 (1)	0,0033 (8)
$\gamma_{37,17}$ (Ra)	219,8 (1)	0,0008
$\gamma_{26,6}$ (Ra)	221,22 (5)	0,022 (6)
$\gamma_{16,0}$ (Ra)	225,26 (10)	0,003 (1)
$\gamma_{22,3}$ (Ra)	225,26 (10)	0,062 (6)
$\gamma_{21,2}$ (Ra)	228,6 (1)	0,0006 (2)
$\gamma_{21,1}$ (Ra)	234,8 (1)	0,0008 (2)
$\gamma_{38,19}$ (Ra)	234,8 (1)	0,00084
$\gamma_{18,0}$ (Ra)	236,249 (20)	0,174 (9)
$\gamma_{22,1}$ (Ra)	242,6 (2)	0,083 (8)
$\gamma_{31,10}$ (Ra)	244,4 (1)	0,0013 (3)
$\gamma_{25,3}$ (Ra)	250,1 (1)	0,00034 (16)
$\gamma_{26,5}$ (Ra)	252,43 (3)	0,095 (12)
$\gamma_{24,1}$ (Ra)	259,08 (4)	0,034 (5)
$\gamma_{25,1}$ (Ra)	267,4 (1)	0,0008 (3)
$\gamma_{33,9}$ (Ra)	274,1 (1)	0,0007 (2)
$\gamma_{43,27}$ (Ra)	276,85 (10)	0,0042 (10)
$\gamma_{30,8}$ (Ra)	278,65 (5)	0,0068 (8)
$\gamma_{44,27}$ (Ra)	281,27 (10)	0,007 (1)
$\gamma_{33,8}$ (Ra)	282,6 (1)	0,0038 (7)
$\gamma_{30,6}$ (Ra)	289,62 (5)	0,0150 (17)
$\gamma_{33,6}$ (Ra)	293,78 (10)	0,0065 (8)
$\gamma_{26,1}$ (Ra)	296,21 (10)	0,0165 (17)
$\gamma_{38,12}$ (Ra)	298,72 (12)	0,0070 (8)
$\gamma_{28,2}$ (Ra)	303,75 (10)	0,0017 (30)
$\gamma_{39,12}$ (Ra)	307,3 (1)	0,006 (3)
$\gamma_{28,1}$ (Ra)	310,1 (1)	0,0020 (3)
$\gamma_{45,29}$ (Ra)	313,3 (1)	0,0037 (11)
$\gamma_{29,2}$ (Ra)	317,8 (1)	0,00055 (14)
$\gamma_{42,23}$ (Ra)	320,8 (1)	0,00016 (7)
$\gamma_{31,5}$ (Ra)	324,6 (1)	0,00043 (13)
$\gamma_{45,28}$ (Ra)	327,9 (1)	0,003
$\gamma_{27,0}$ (Ra)	327,9 (1)	0,016 (3)
$\gamma_{38,10}$ (Ra)	328,2 (1)	0,0020 (8)
$\gamma_{34,5}$ (Ra)	329,9 (2)	0,0006 (2)
$\gamma_{37,8}$ (Ra)	334,74 (10)	0,00043 (11)
$\gamma_{43,22}$ (Ra)	336,7 (1)	0,0082 (1)
$\gamma_{39,10}$ (Ra)	336,7 (1)	0,0001
$\gamma_{45,26}$ (Ra)	341,1 (1)	0,0008 (2)
$\gamma_{34,4}$ (Ra)	344,3 (1)	0,0001
$\gamma_{36,5}$ (Ra)	347,4 (1)	0,0006 (1)

	Energy keV	Photons per 100 disint.
$\gamma_{42,19}$ (Ra)	349,4 (1)	0,0001
$\gamma_{29,0}$ (Ra)	349,4 (1)	0,0004 (1)
$\gamma_{32,3}$ (Ra)	351,7 (1)	0,0005 (1)
$\gamma_{38,9}$ (Ra)	358,0 (1)	0,006 (1)
$\gamma_{43,19}$ (Ra)	361,0 (1)	0,0006 (1)
$\gamma_{38,8}$ (Ra)	366,5 (1)	0,0004 (1)
$\gamma_{39,9}$ (Ra)	366,5 (1)	0,0001
$\gamma_{43,18}$ (Ra)	368,1 (1)	0,0019 (3)
$\gamma_{31,1}$ (Ra)	368,9 (1)	0,0019 (3)
$\gamma_{39,8}$ (Ra)	375,1 (1)	0,0003 (1)
$\gamma_{38,6}$ (Ra)	377,4 (1)	0,0029 (3)
$\gamma_{43,16}$ (Ra)	379,4 (1)	0,0013 (2)
$\gamma_{39,6}$ (Ra)	386,4 (1)	0,0008 (2)
$\gamma_{32,0}$ (Ra)	395,3 (2)	0,0008 (1)
$\gamma_{34,0}$ (Ra)	399,9 (2)	0,00014 (6)
$\gamma_{35,0}$ (Ra)	403,3 (1)	0,0018 (2)
$\gamma_{38,5}$ (Ra)	408,5 (1)	0,0010 (1)
$\gamma_{41,9}$ (Ra)	414,61 (10)	0,0003 (1)
$\gamma_{39,5}$ (Ra)	417,4 (1)	0,0014 (2)
$\gamma_{45,19}$ (Ra)	419,9 (2)	0,0006 (1)
$\gamma_{43,12}$ (Ra)	424,8 (1)	0,0032 (3)
$\gamma_{38,3}$ (Ra)	435,3 (1)	0,0031 (4)
$\gamma_{39,3}$ (Ra)	444,1 (1)	0,0005 (1)
$\gamma_{38,1}$ (Ra)	452,6 (1)	0,0017 (2)
$\gamma_{43,10}$ (Ra)	454,76 (10)	0,0105 (11)
$\gamma_{44,10}$ (Ra)	459,1 (3)	0,001
$\gamma_{41,5}$ (Ra)	465 (1)	0,0001
$\gamma_{38,0}$ (Ra)	478,0 (1)	0,0037 (4)
$\gamma_{45,12}$ (Ra)	483,7 (1)	0,0018 (2)
$\gamma_{39,0}$ (Ra)	487,3 (2)	0,0004 (1)
$\gamma_{43,8}$ (Ra)	492,9 (1)	0,00152 (16)
$\gamma_{43,6}$ (Ra)	503,6 (1)	0,00005
$\gamma_{41,2}$ (Ra)	503,6 (1)	0,00012 (5)
$\gamma_{45,10}$ (Ra)	513,5 (2)	0,0007 (2)
$\gamma_{42,5}$ (Ra)	523,5 (1)	0,0005 (1)
$\gamma_{41,0}$ (Ra)	535,1 (1)	0,0013 (2)
$\gamma_{43,5}$ (Ra)	535,1 (1)	0,0002
$\gamma_{45,9}$ (Ra)	543,0 (3)	0,0001
$\gamma_{42,3}$ (Ra)	549,8 (5)	0,0001
$\gamma_{45,8}$ (Ra)	551,7 (2)	0,00011 (4)
$\gamma_{43,3}$ (Ra)	561,8 (1)	0,0019 (2)
$\gamma_{44,3}$ (Ra)	565,7 (3)	0,0009 (1)
$\gamma_{43,2}$ (Ra)	573,0 (1)	0,0028 (3)
$\gamma_{43,1}$ (Ra)	579,2 (2)	0,0006 (1)
$\gamma_{42,0}$ (Ra)	592,5 (1)	0,0003 (1)
$\gamma_{45,5}$ (Ra)	594,4 (3)	0,0001

7 Main Production Modes

$$\left\{ \begin{array}{l} \text{U} - 233(\alpha)\text{Th} - 229 \\ \text{Possible impurities : U} - 232, \text{U} - 238 \end{array} \right.$$

8 References

- A.C. ENGLISH, T. E. CRANSHAW, P. DEMERS, J. A. HARVEY, E. P. HINCKS, J. V. JELLEY, A. N. MAY. Phys. Rev. C72 (1947) 253
(Half-life)
- F. HAGEMANN, L.I. KATZIN, M.H. STUDIER, A. GHIORSO, G.T. SEABORG. Phys. Rev. 72 (1947) 252
(Half-life)
- F. HAGEMANN, L.I. KATZIN, M.H. STUDIER, G.T. SEABORG, A. GHIORSO. Phys. Rev. 79 (1950) 435
(Half-life, Production modes)
- S.A. BARANOV, V.M.SHATINSKII, V.M.KULAKOV, Y.F.RODIONOV. Yad. Fiz. 11 (1970) 925
(alpha energy)
- E.F.TRETYAKOV, N.I.TRETYAKOVA, V.F.KONYAEV, Y.V.KHRUDEV, A.C.BEDA, G.F.KARTASHEV, I.N.VISHNEVSKII. Izv.Akad.Nauk SSSR, Ser.Fiz. 34 (1970) 856
(alpha energies, 225Ra levels, gamma ray energies, conversion electrons)
- F.P. LARKINS. At. Data Nucl. Data Tables 20 (1977) 311
(Electron Binding Energies)
- A.RYTZ. At. Data Nucl. Data Tables 23 (1979) 507
(alpha energies)
- J.K.DICKENS, J.W.McCONNELL. Radiochem.Radioanal.Lett. 47 (1981) 331
(gamma ray energies and intensities)
- S. S. RATTAN, A. V. R. REDDY, V. S. MALLAPURKAR, R. J. SINGH, SATYA PRAKASH, M. V. RAMANIAH. Phys. Rev. 27 (1983) 327
(gamma ray energies and abundances, Ra X-ray intensities)
- R.G.HELMER, C.W.REICH, M.A.LEE, I.AHMAD. Int.J.Appl.Radiat.Isotop. 37 (1986) 139
(gamma ray energies and emission probabilities)
- R.G. HELMER, M.A. LEE, C.W. REICH, I. AHMAD. Nucl. Phys. A474 (1987) 77
(alpha energies, alpha intensities, gamma ray energies, gamma ray intensities, conversion coefficient)
- G.J. MILLER, J. C. McGEORGE, I. ANTHONY, R. O. OWENS. Phys. Rev. C36 (1987) 420
(Half-life of daughter 225Ra)
- N.E.HOLDEN. Pure & Appl. Chem 61 (1989) 1483
(Half-life)
- S.J.GOLDSTEIN, M.T.MURRELL, R.W.WILLIAMS. Phys. Rev. C40 (1989) 2793
(229Th Half-life)
- A. RYTZ. At. Data Nucl. Data Tables 47 (1991) 205
(Half-life of 229Th)
- E.SCHÖNFELD, H.JANSSEN. Nucl. Instrum. Methods Phys. Res. A369 (1996) 527
(Atomic data)
- R.B. FIRESTONE. Table of Isotopes 8th Ed., V.S. Shirley, C.M. Baglin, S.Y.F. Chu, J.Zipkin eds., John Wiley and Sons Inc., New York 2 (1996)
(Electron Binding energies)
- E.SCHÖNFELD, G.RODLOFF. PTB Report 6.11-1998-1 6.11 (1998) 1
(Auger electrons)
- E.SCHÖNFELD, G.RODLOFF. PTB Report 6.11-1999-1 6.11 (1999) 1
(K-x rays)
- E.SCHÖNFELD, H. JANSSEN. Appl. Rad. Isotopes 52 (2000) 595
(X-ray and Auger Electron emission probabilities)
- J. GASPARRO, G. ARDISSON, V. BARCI. Phys. Rev. C62 (2000) 064305
(Gamma ray energies and intensities)
- G. AUDI, A.H. WAPSTRA, C. THIBAUT. Nucl. Phys. A729 (2003) 337
(Q value)
- A.K. JAIN, R.RAUT, J.K.TULI. Nucl.Data Sheets 110 (2009) 1409
(alpha energies, alpha intensities, gamma energies, gamma intensities, Ra-225 levels)

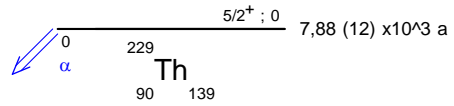

γ Emission intensities per 100 disintegrations

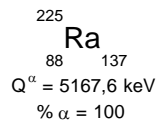
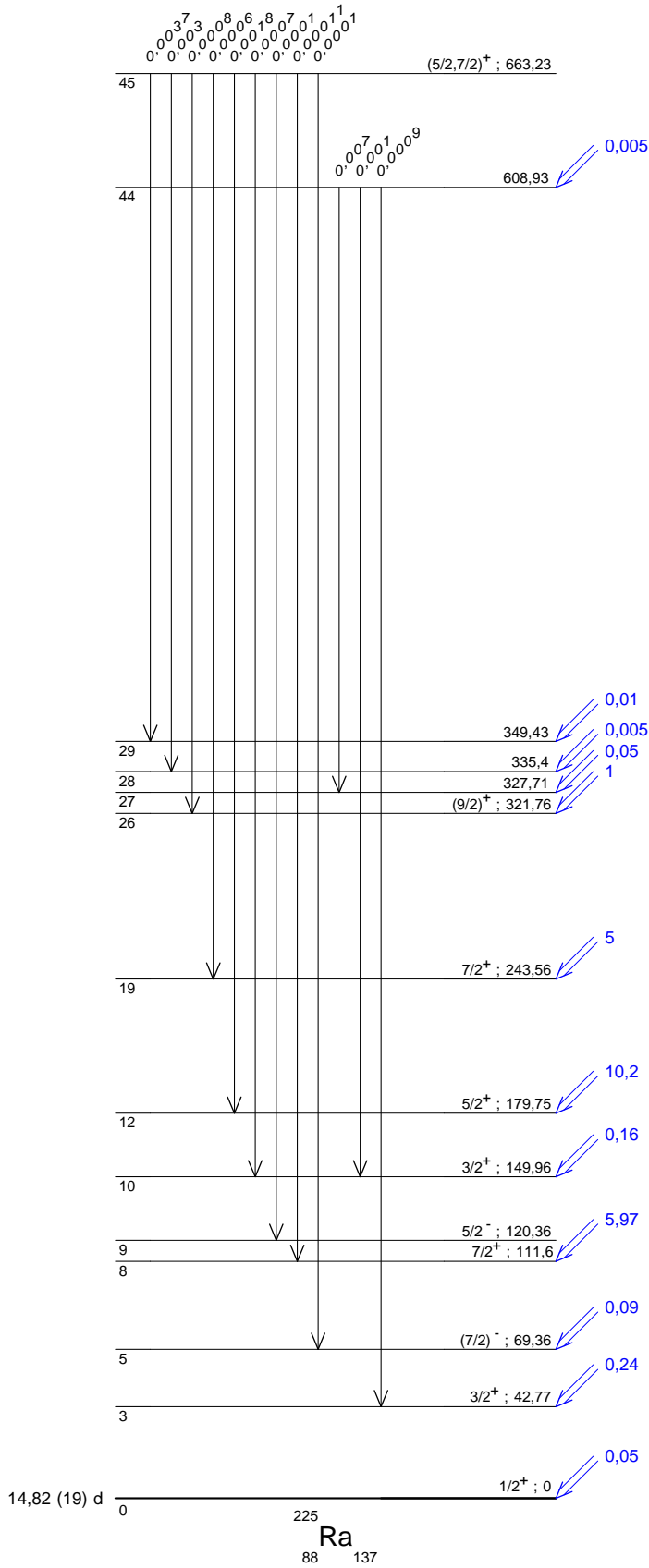

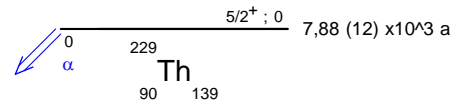

γ Emission intensities per 100 disintegrations

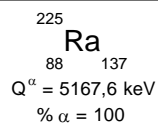
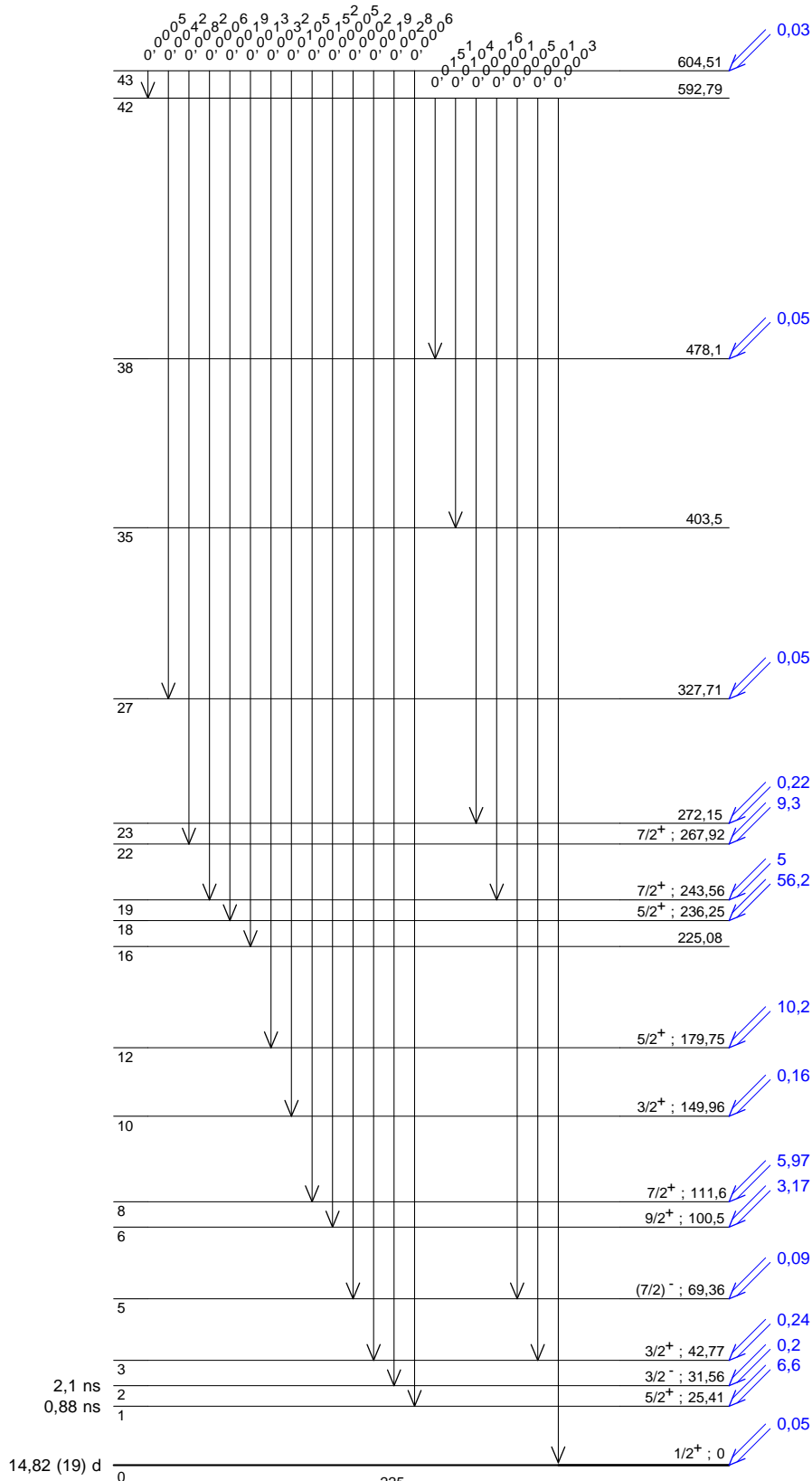

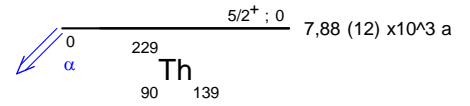

γ Emission intensities per 100 disintegrations

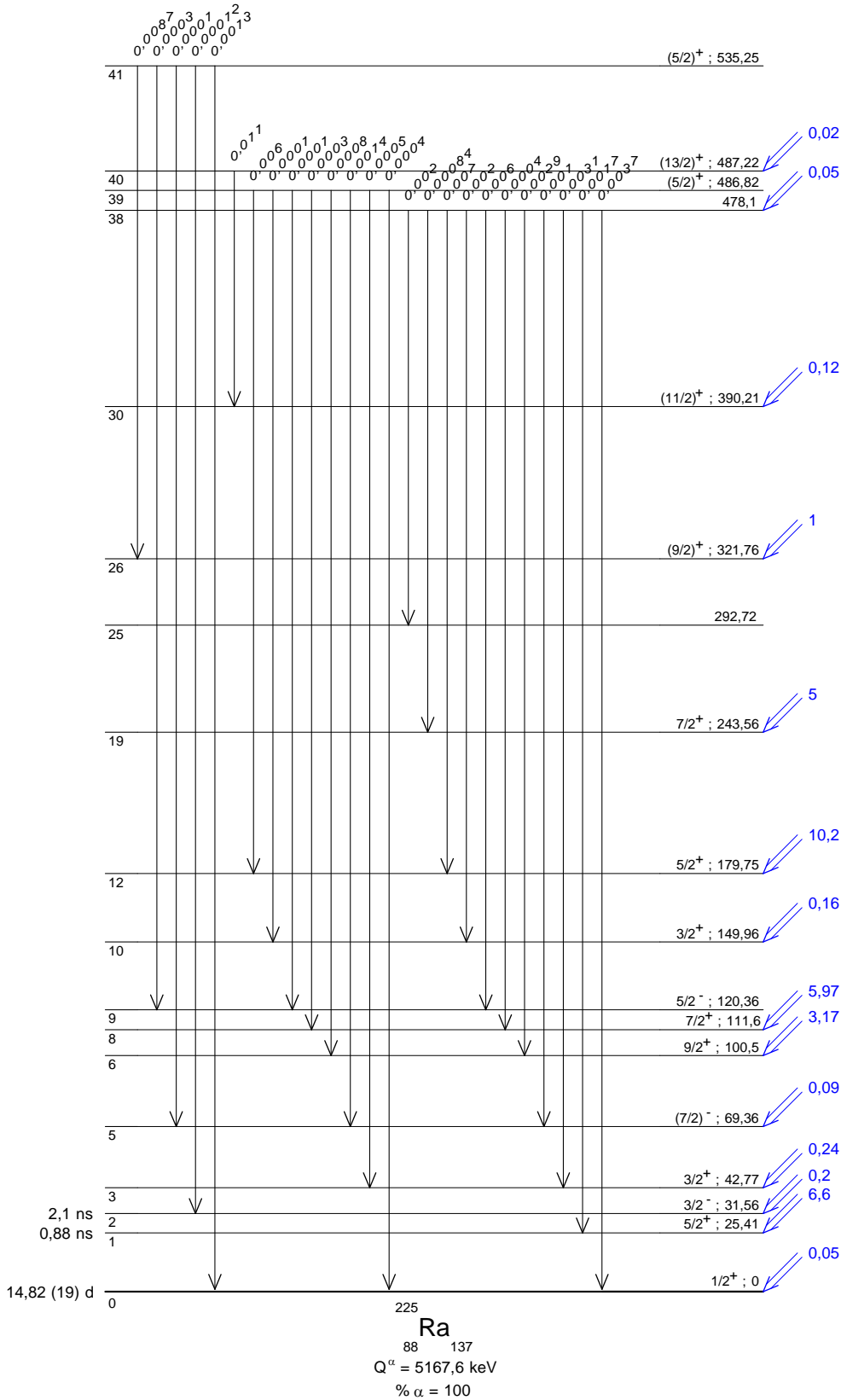

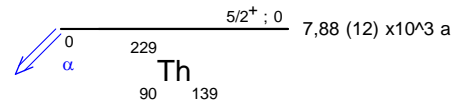

γ Emission intensities per 100 disintegrations

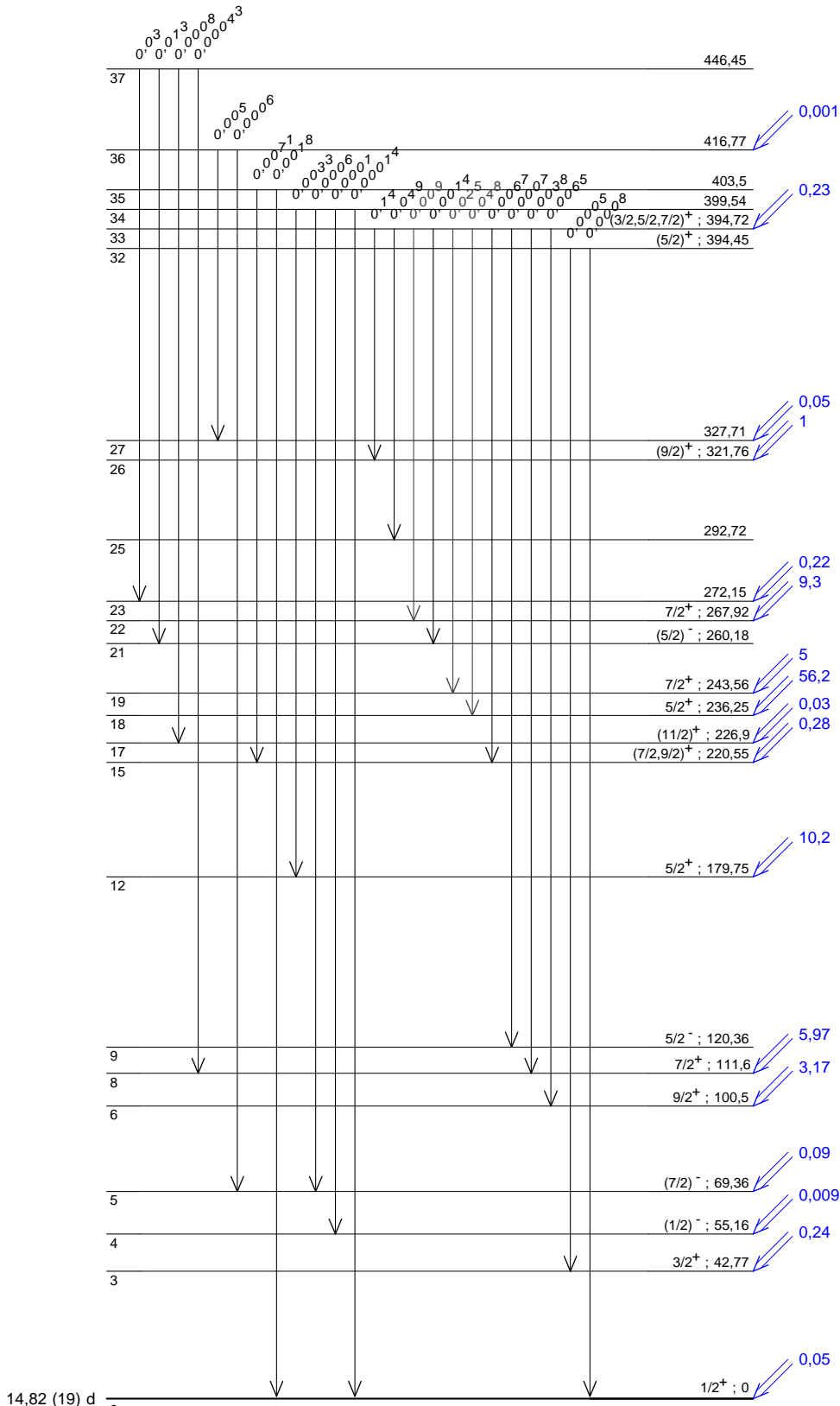

14,82 (19) d

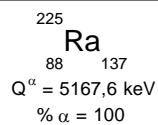

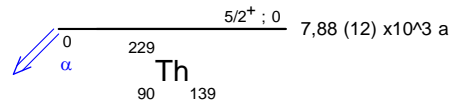

γ Emission intensities per 100 disintegrations

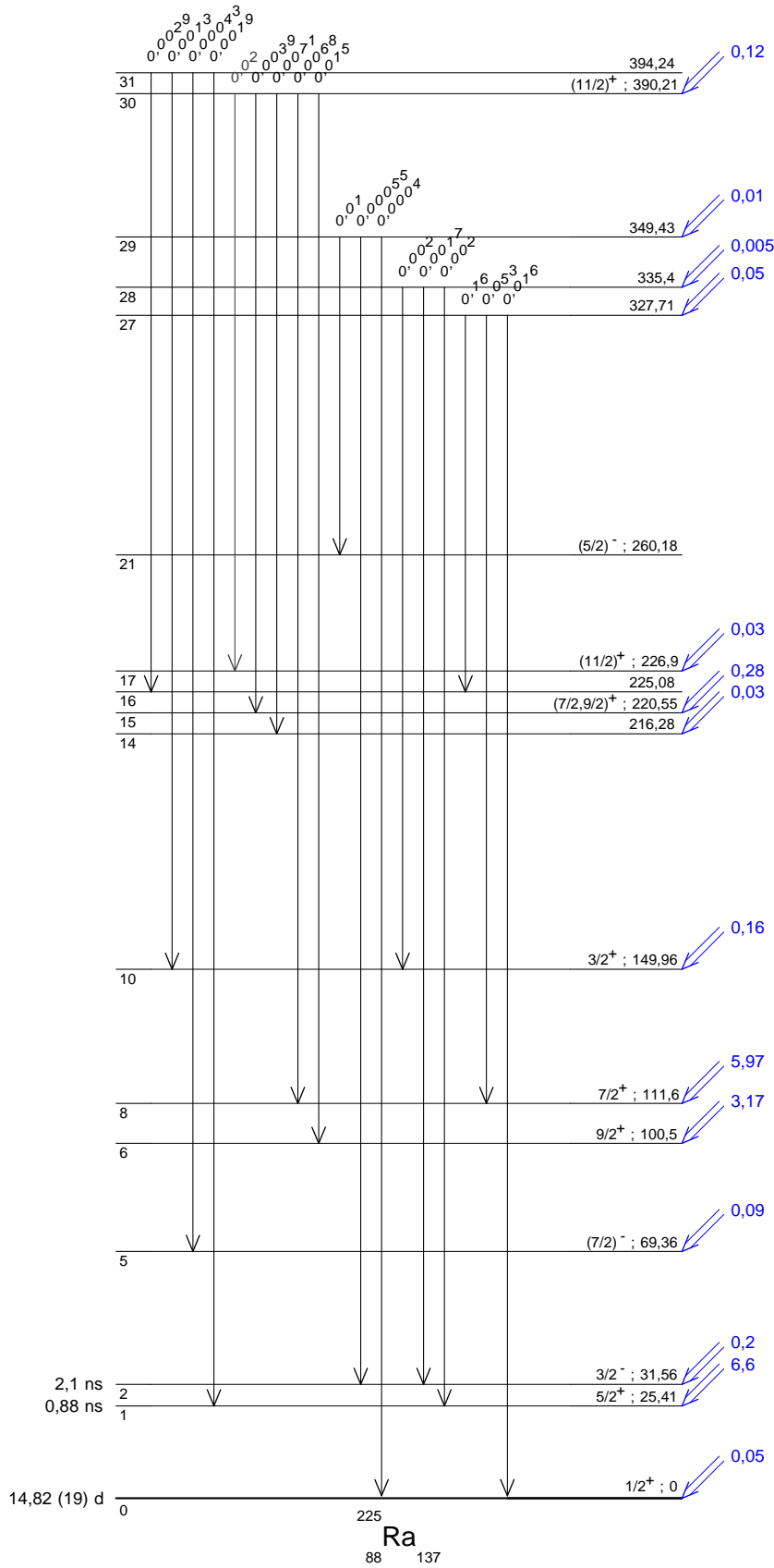

²²⁵Ra
 88 137
 Q ^{α} = 5167,6 keV
 % α = 100

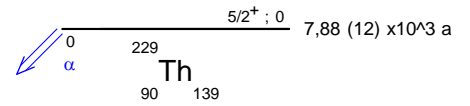

γ Emission intensities per 100 disintegrations

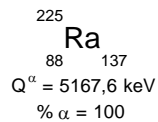
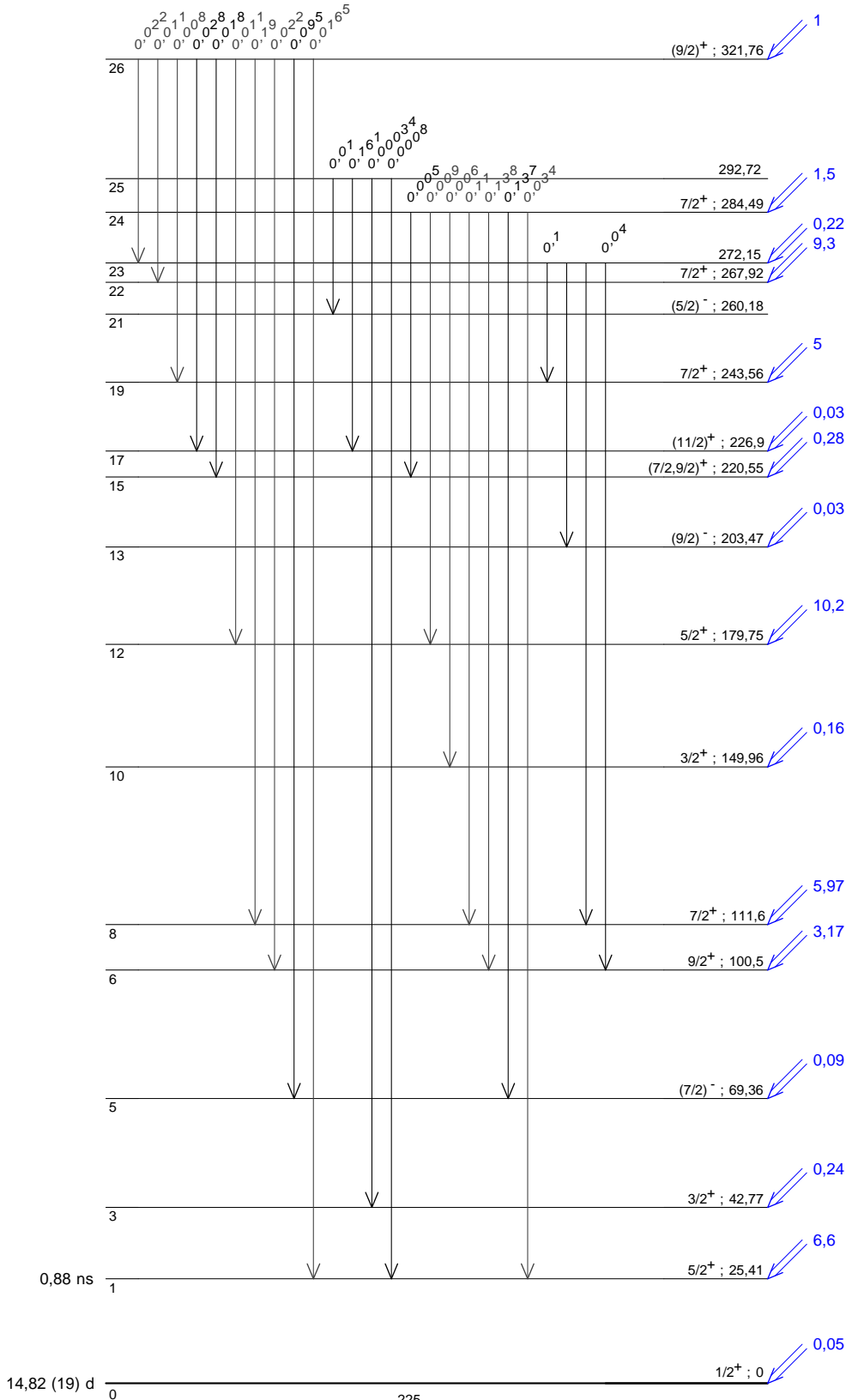

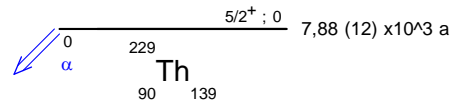

γ Emission intensities per 100 disintegrations

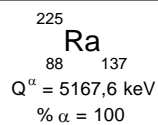
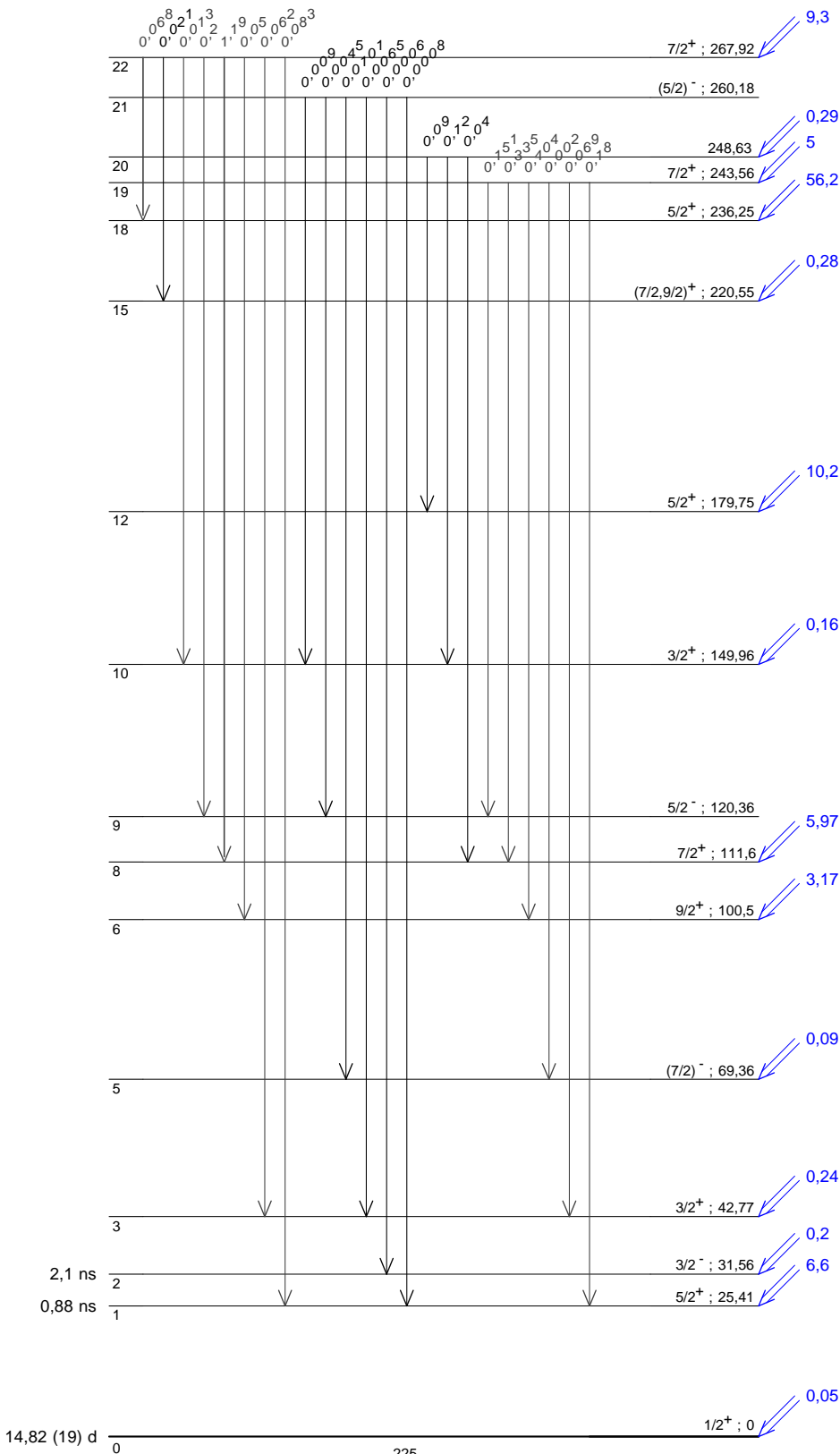

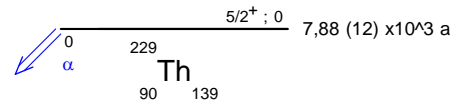

γ Emission intensities per 100 disintegrations

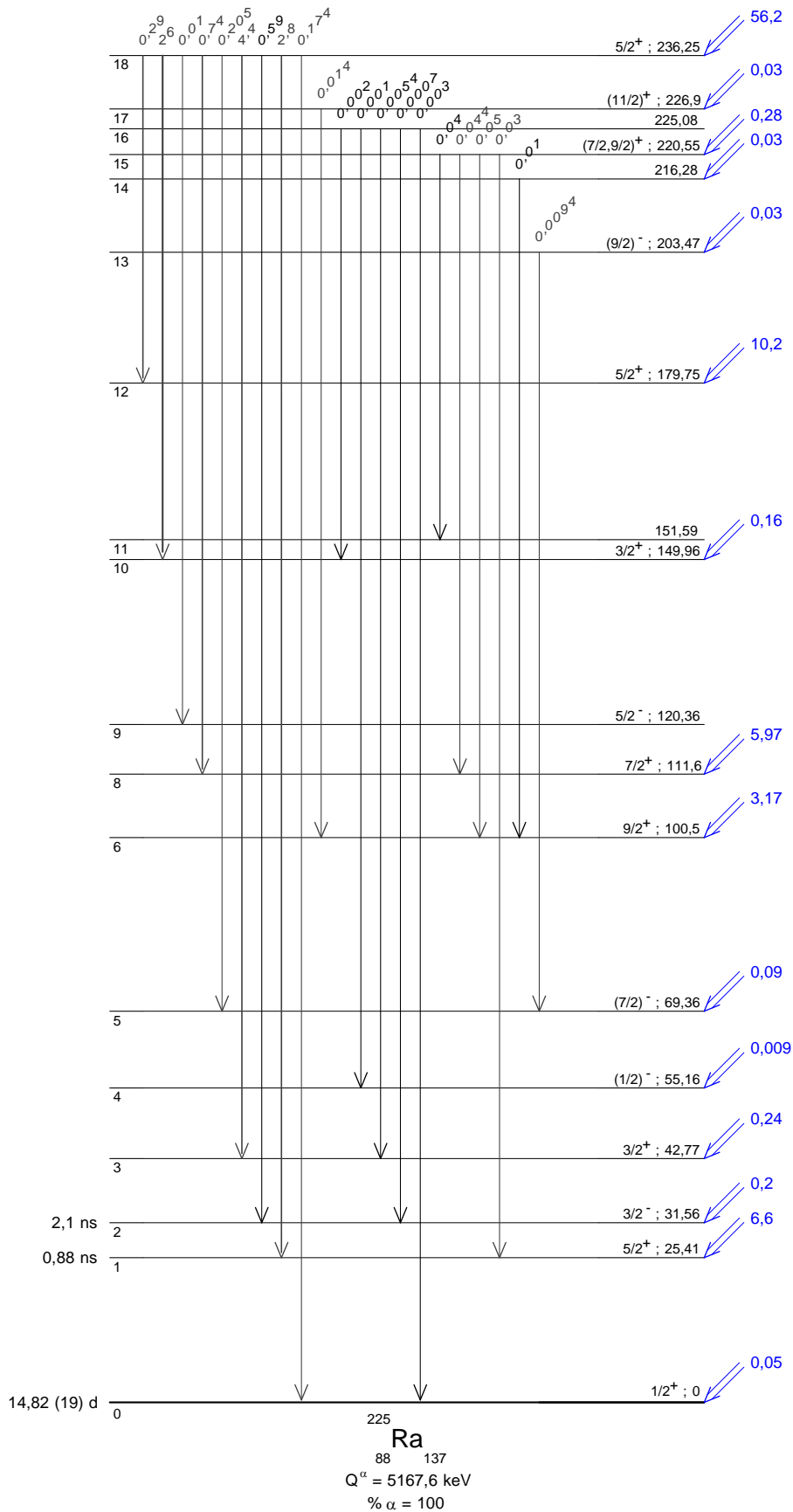

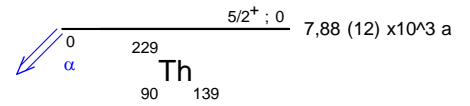

γ Emission intensities per 100 disintegrations

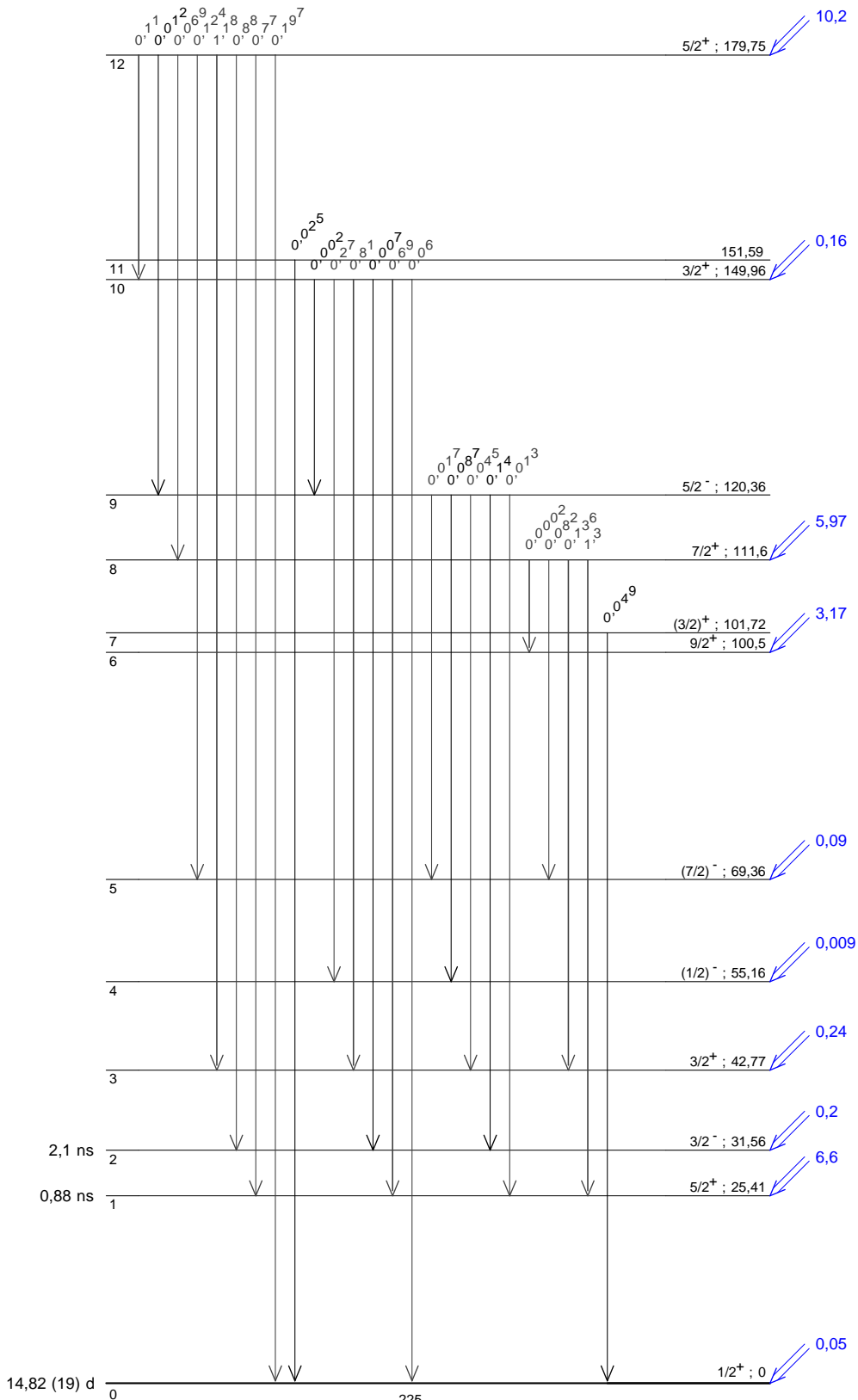

²²⁵Ra
₈₈ ¹³⁷
 $Q^\alpha = 5167,6$ keV
 $\% \alpha = 100$

